

Kit 1408

NISSAN King Cab, 2-dr Single Cab, 05–
NISSAN King Cab, 4-dr Crew Cab, 05–
NISSAN Navara, 4-dr Crew Cab, 05–

480R
754

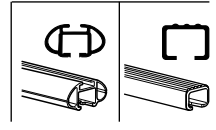
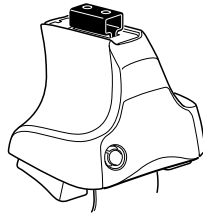

480

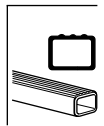
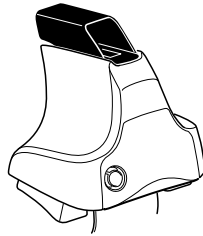

750

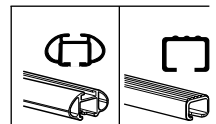
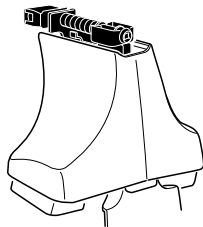

2-dr **Max.**
30 kg/66 lbs

4-dr **Max.**
75 kg/165 lbs

+

x1

x4

x4

x4

x1

x4

x4

x4

x1

x4

x4

750

x2	x2 23 mm	x1 17 mm	x2 23 mm	x2
x2	x2	x2 23 mm	x2	x2
	x4	x2	x2	
	x4	x4		

771 **x4**

174 **x4**

x1

Kit

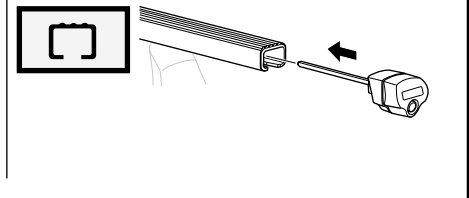
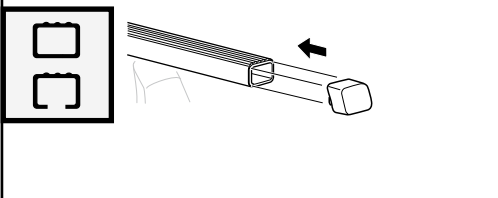
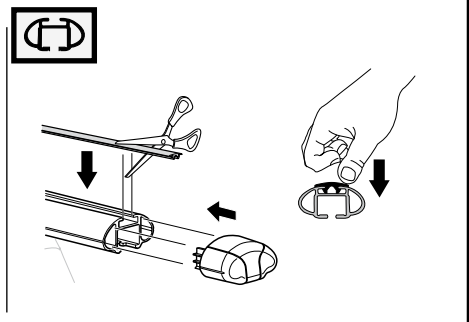
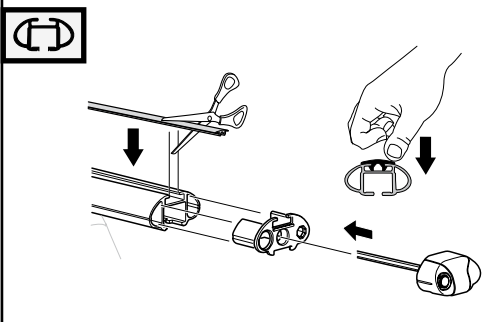
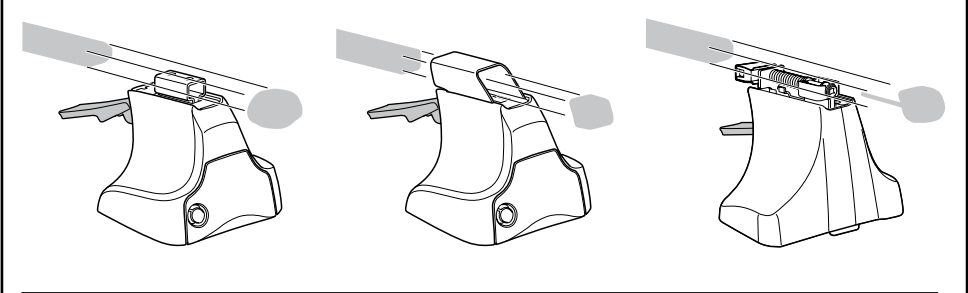
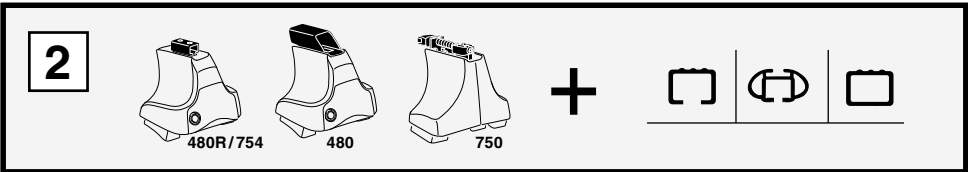
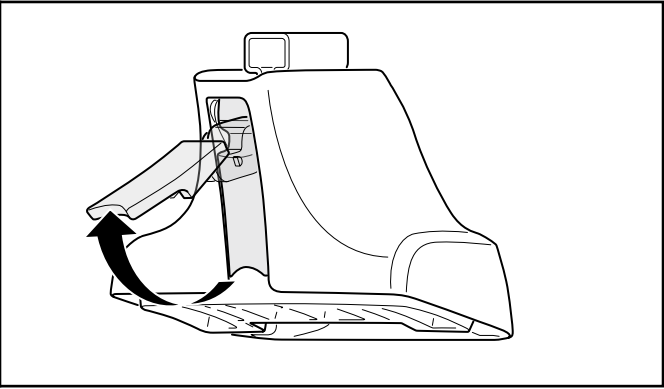
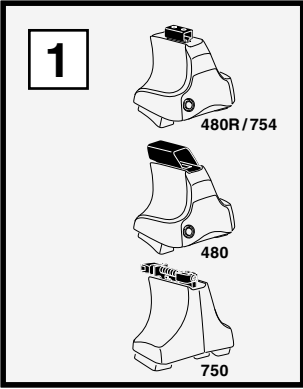

3

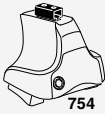

754



750



1

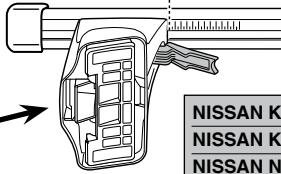
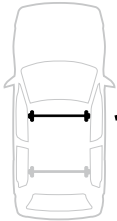

2

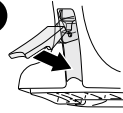

	X
NISSAN King Cab, 2-dr Single Cab, 05-	46,5
NISSAN King Cab, 4-dr Crew Cab, 05-	46,5
NISSAN Navara, 4-dr Crew Cab, 05-	46,5

1

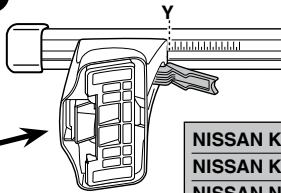

2

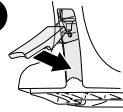

	Y
NISSAN King Cab, 2-dr Single Cab, 05-	-
NISSAN King Cab, 4-dr Crew Cab, 05-	45
NISSAN Navara, 4-dr Crew Cab, 05-	45



480R



480

1

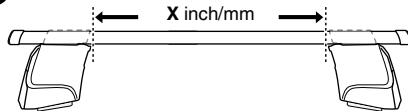
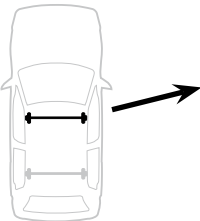

2

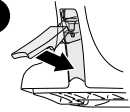

	X inch	X mm
NISSAN King Cab, 2-dr Single Cab, 05-	43 ⁷ / ₈ "	1116 mm
NISSAN King Cab, 4-dr Crew Cab, 05-	43 ⁷ / ₈ "	1116 mm
NISSAN Navara, 4-dr Crew Cab, 05-	43 ⁷ / ₈ "	1116 mm

1

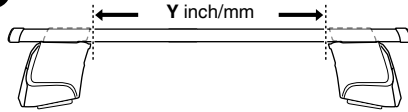
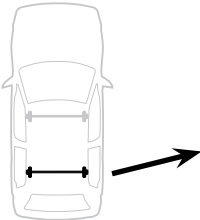

2

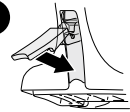

	Y inch	Y mm
NISSAN King Cab, 2-dr Single Cab, 05-	-	-
NISSAN King Cab, 4-dr Crew Cab, 05-	43 ³ / ₈ "	1101 mm
NISSAN Navara, 4-dr Crew Cab, 05-	43 ³ / ₈ "	1101 mm

4

NISSAN King Cab, 2-dr Single Cab, 05--

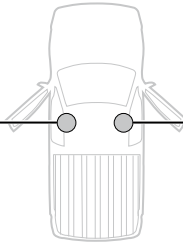

NISSAN King Cab, 4-dr Crew Cab, 05--
NISSAN Navara, 4-dr Crew Cab, 05--

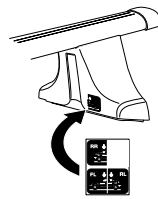
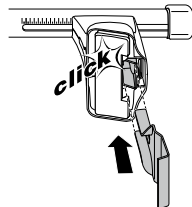
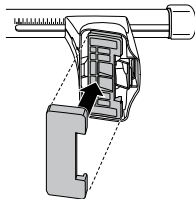
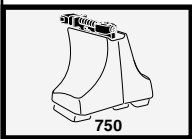
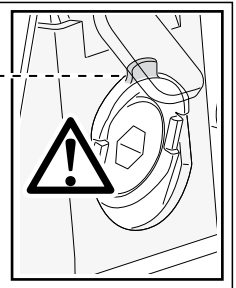
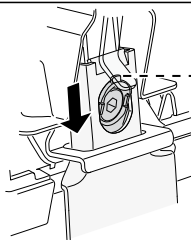
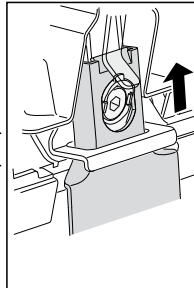
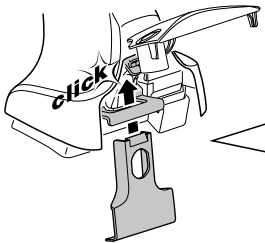
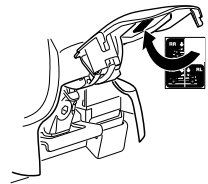
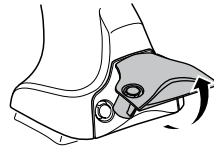
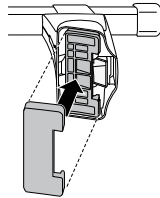
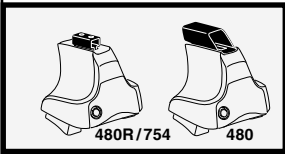
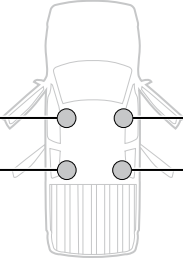

5



	X mm	Y mm	X inch	Y inch
NISSAN King Cab, 2-dr Single Cab, 05-	260 mm	-	10 1/4"	-
NISSAN King Cab, 4-dr Crew Cab, 05-	260 mm	750 mm	10 1/4"	29 1/2"
NISSAN Navara, 4-dr Crew Cab, 05-	260 mm	750 mm	10 1/4"	29 1/2"

NISSAN King Cab, 2-dr Single Cab, 05-

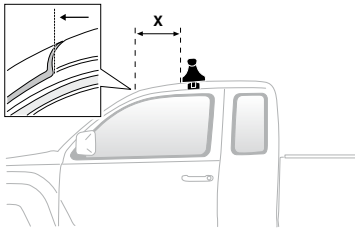

**NISSAN King Cab, 4-dr Crew Cab, 05-
NISSAN Navara, 4-dr Crew Cab, 05-**

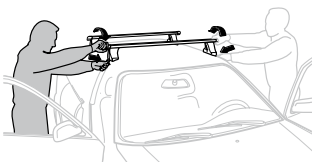
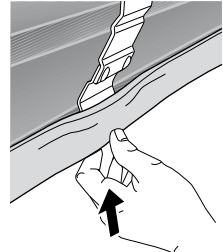
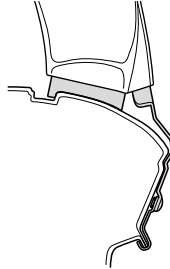
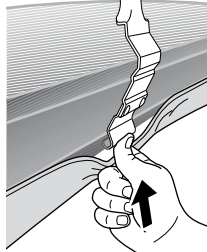
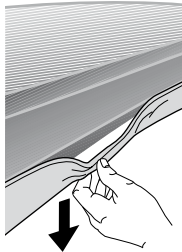
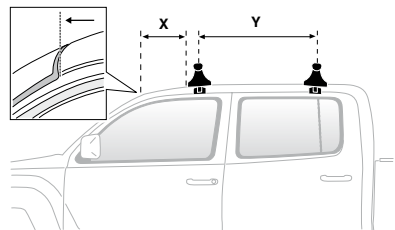

- GB/US** Tighten alternately
- D** Die Schrauben abwechselnd anziehen
- F** Serrer alternativement chaque côté
- NL** Afwisselend aan de linker- en de rechterkant aandraaien
- I** Alternare il serraggio delle viti
- E** Apretar alternativamente
- PT** Aperte alternadamente
- S** Dra åt växelvis
- FIN** Kierrä vuorotellen
- EST** Pinguldage vaheldumisi
- LAT** Pielvelciēt pamišus
- LIT** Užsukinėkite pakaitomis
- PL** Śruby dokręcaj naprzemiennie
- RU** Затягивайте попеременно

- CZ** Pokręťta bagazníka dokręcaj dokręcaj naprzemiennie.
- SK** Doťahujte striedavo
- SLO** Privijajte izmenično.
- HR** Naizmjenično zategnite
- HU** Egymástól függetlenül szorítandó
- GR** Σφίγγετε εναλλάξ
- TR** Dönüşümlü sıkın
- 中文** 交替拧紧
- 한국어** 번갈아 가며 조이십시오.
- 日本語** 交互に締め付けてください。
- ไทย** ชั้้นในแบบสลับ

6

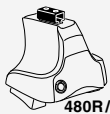

480R/754



480

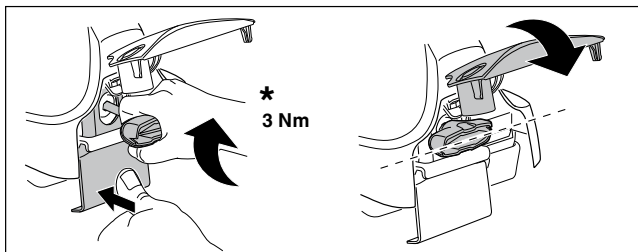
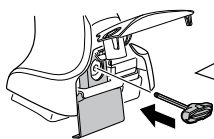

*
3 Nm

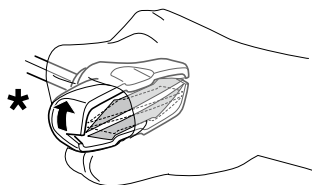

*

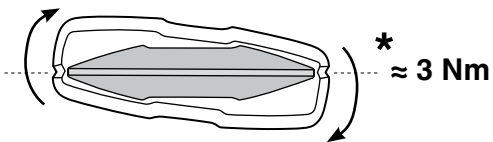

*
≈ 3 Nm

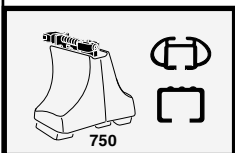
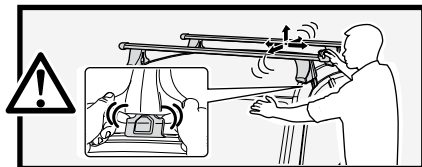

750

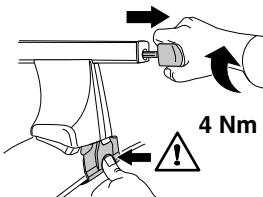

4 Nm

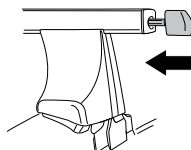

7



x1
17 mm

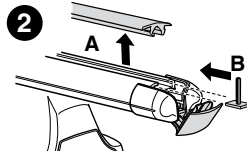
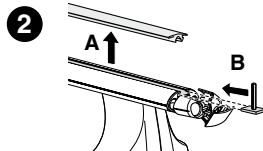
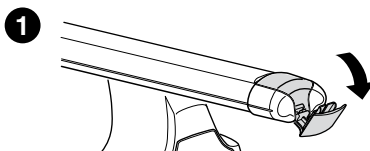
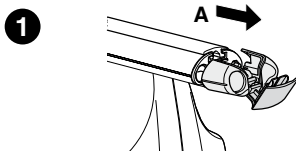
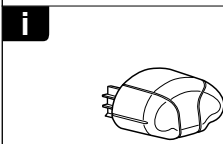
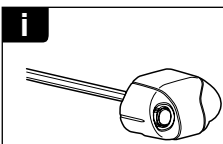
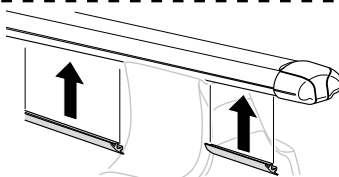

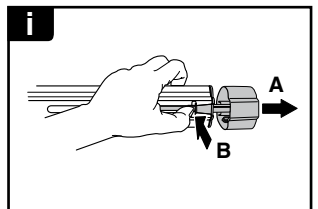
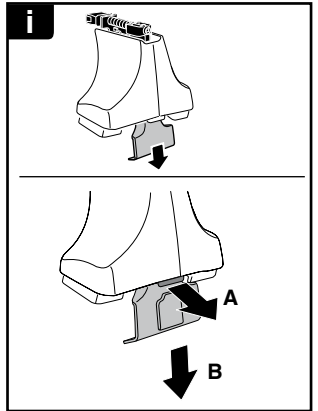

THULE
SWEDEN
**ONE
KEY
SYSTEM**



- 544 (x4)
- 596 (x6)
- 588 (x8)
- NA 510 (x10)
- EUR 452 (x12)
- ASIA



WW ▶ Thule Sweden AB, Box 69, 330 33 Hillerstorp, SWEDEN
NA ▶ Thule Inc., 42 Silvermine Road, Seymour, Connecticut 06483, USA

info@thule.com
customer.service@thule.com

www.thule.com



www.thuleprofessional.com



customer.service@thule.com



Thule Inc., 42 Silvermine Road, Seymour, Connecticut 06483, USA
Thule Sweden AB, Box 69, 330 33 Hillerstorp, SWEDEN

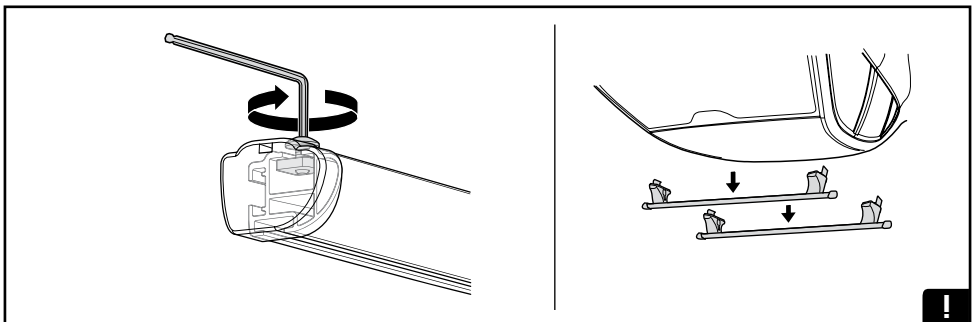
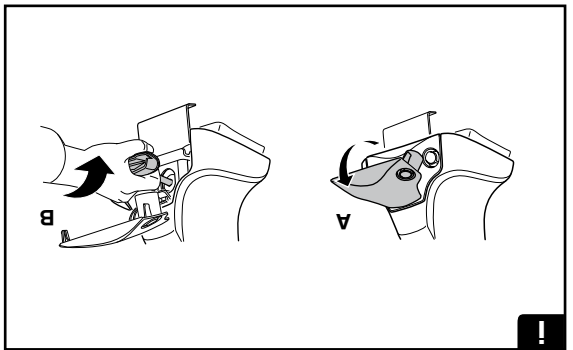
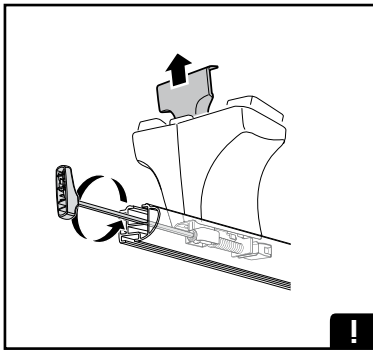
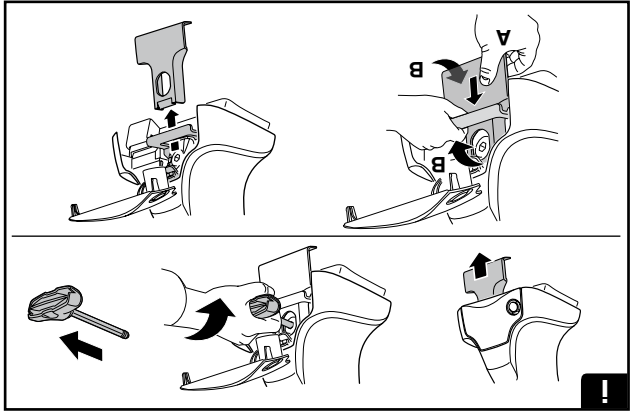
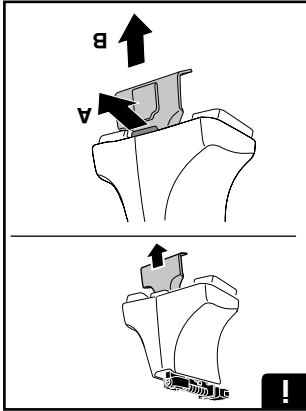

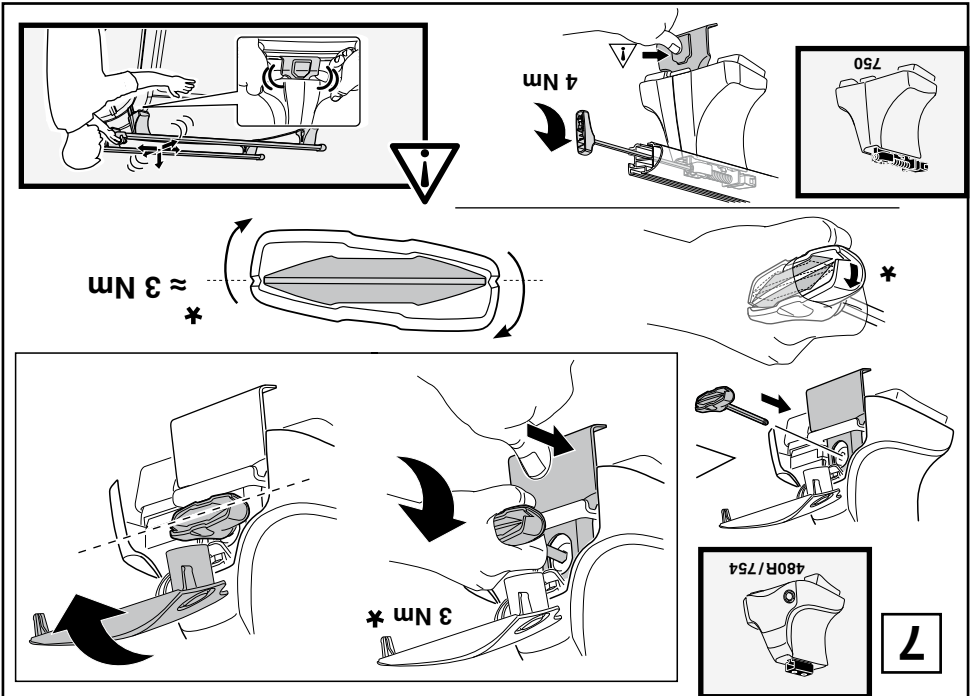
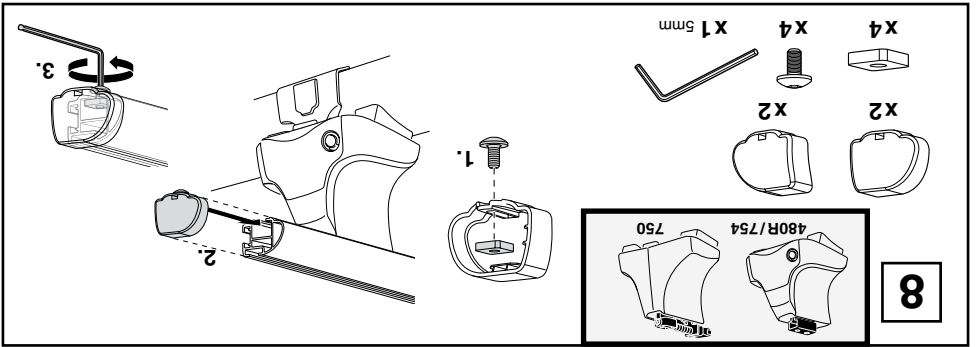
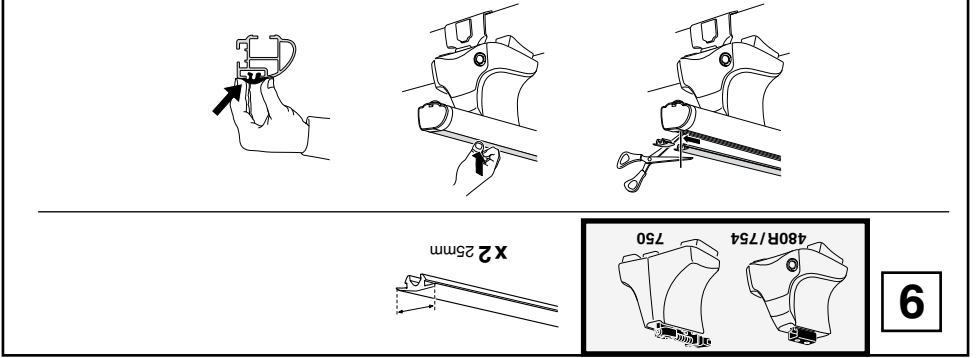

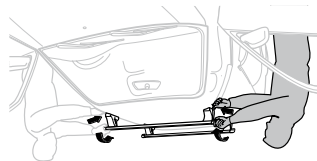

GB/US Tighten alternatívy
D Die Schrauben abwechselnd
anziehen
F Serrer alternativement chaque côté
NL Afwisselend aan de linker- en de
I rechterkant aandraaien
E Alternare il serraggio delle viti
PT Apertar alternadamente
S Dra åt växelvis
FIN Kierrä vuorotellen
EST Pinguldage vaheldumisi
LAT Pielciēt pamīstus
LT Užskinkite pakalomis
PL Słubj dokręcaj naprzemiennie
RU Затягивайте попеременно

CZ Pokrýtá bagazníka dokręcaj dokręcaj naprzemiennie.
SK Dotahujte striedavo
SLO Privijajte izmenično.
HR Natiznjentično zategnite
HU Egymástól fűggetlenül szorítandó
GR Σφιγνείτε εναλλάξ
TR Dönğürtmü şikin
中文 交替持緊
한국어 편갈아 가며 조이십시오.
日本語 交互に締め付けてください。
ИМБ Илмилүүлгэлү

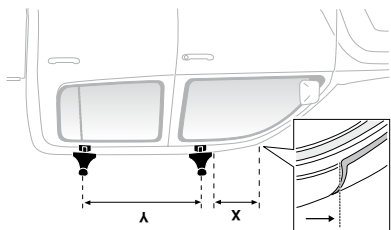
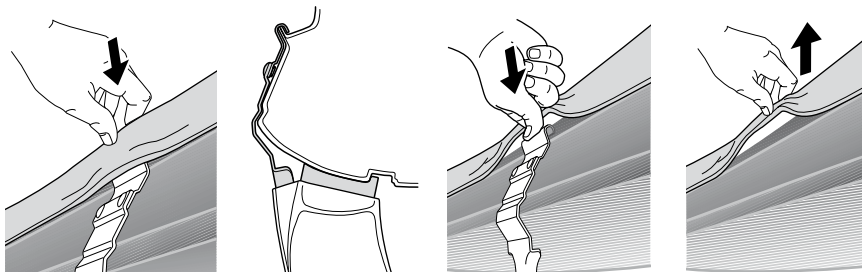

NISSAN Navara, 4-dr Crew Cab, 05-

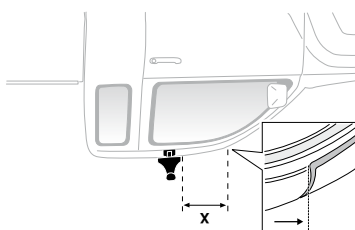

NISSAN King Cab, 2-dr Single Cab, 05-

NISSAN Navara, 4-dr Crew Cab, 05-	260 mm	750 mm	10 1/4"	29 1/2"
NISSAN King Cab, 4-dr Crew Cab, 05-	260 mm	750 mm	10 1/4"	29 1/2"
NISSAN King Cab, 2-dr Single Cab, 05-	260 mm	-	10 1/4"	-
	X mm	Y mm	X inch	Y inch

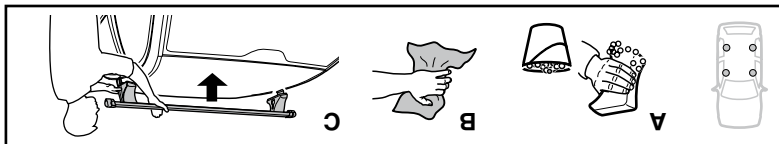

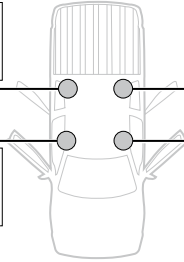
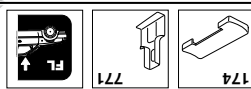
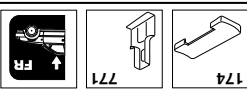
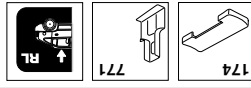
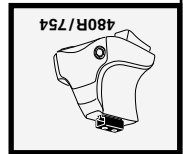
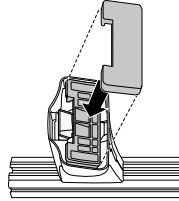
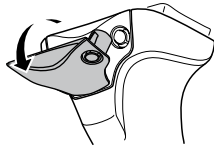
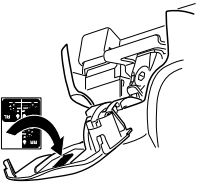
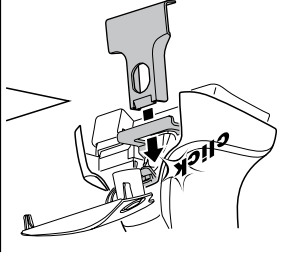
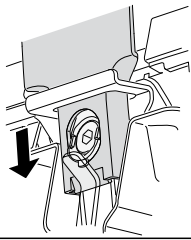
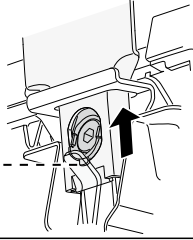
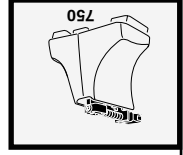
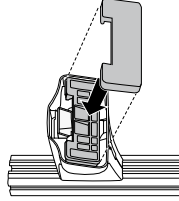
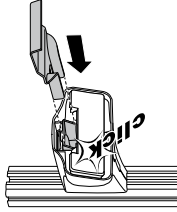
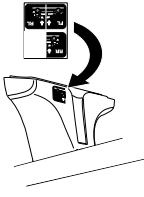

NISSAN King Cab, 4-dr Crew Cab, 05-

NISSAN Navara, 4-dr Crew Cab, 05-

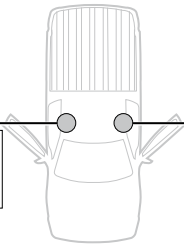
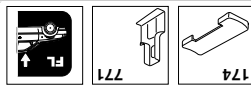

NISSAN King Cab, 2-dr Single Cab, 05-

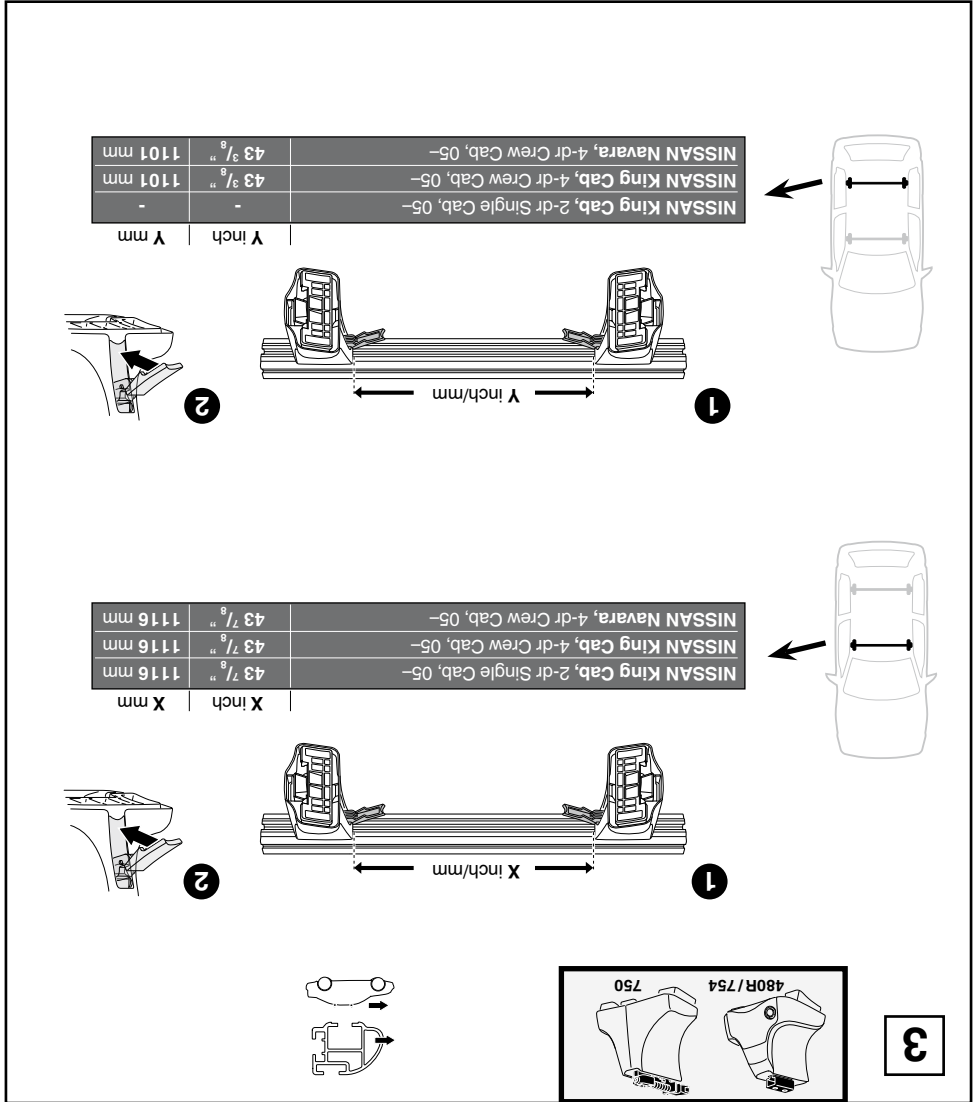
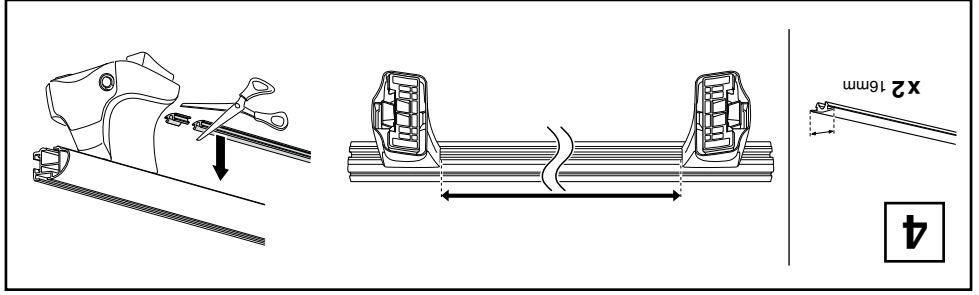

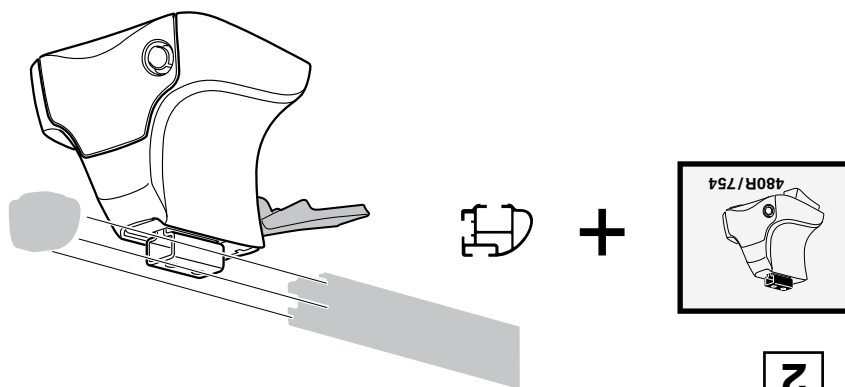
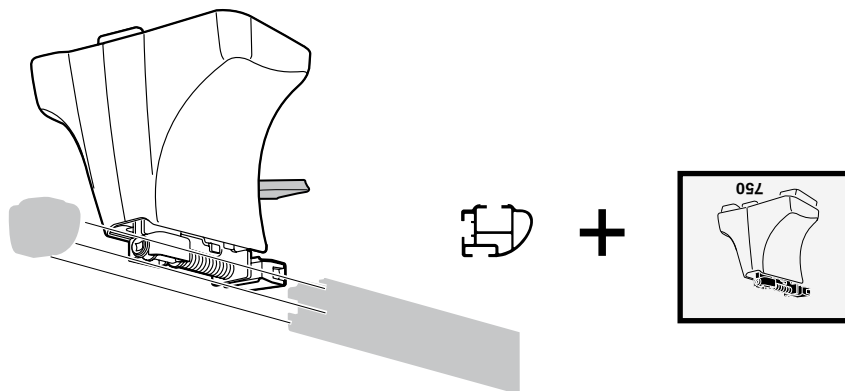

2

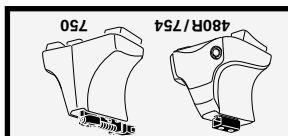
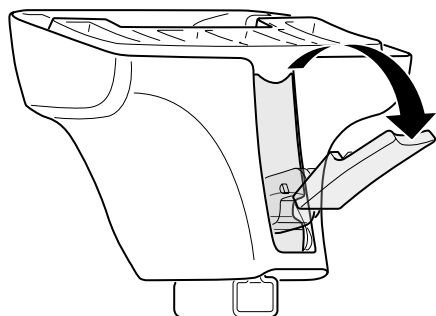

1

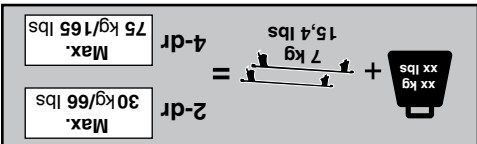
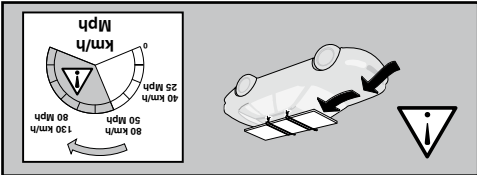
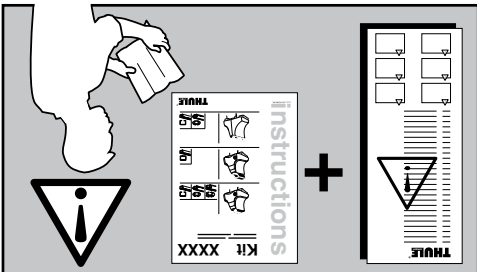
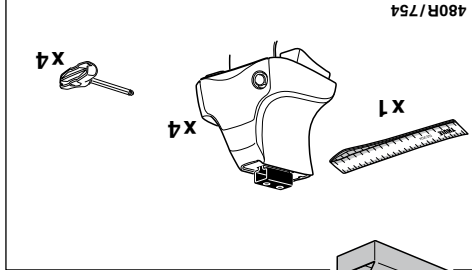
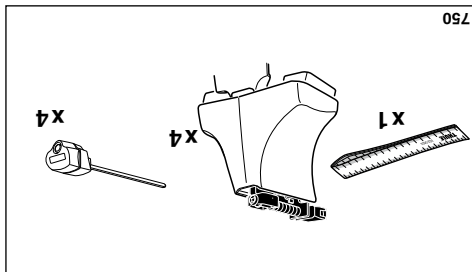
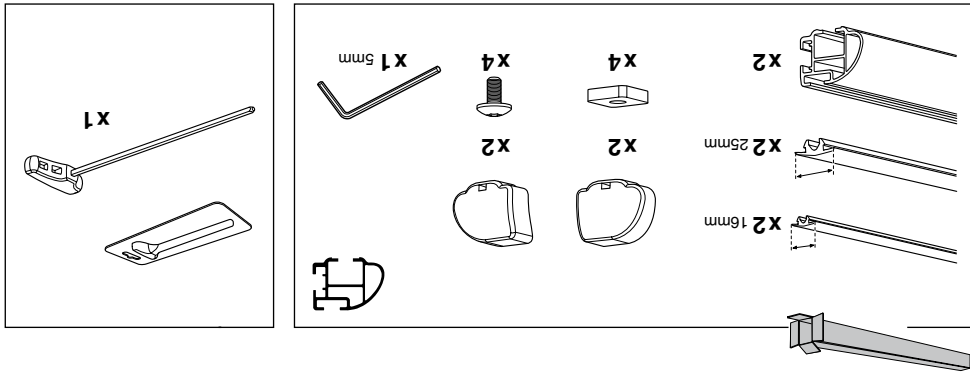
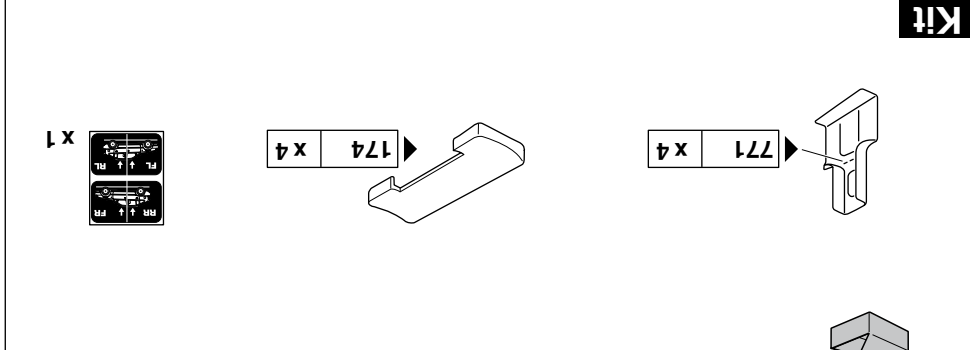

2-dr Max. 30 kg/66 lbs
 + 7 kg
 = 15,4 lbs
4-dr Max. 75 kg/165 lbs

instructions

Kit 1408

- NISSAN King Cab, 2-dr Single Cab, 05-
- NISSAN King Cab, 4-dr Crew Cab, 05-
- NISSAN Navara, 4-dr Crew Cab, 05-

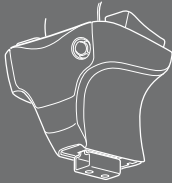

480R

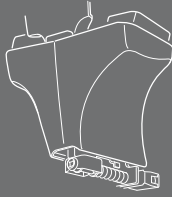
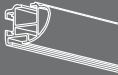

750

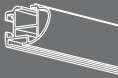

ISO 11154-E

PROFESSIONAL

THULE
SWEDEN