



## Thule Rapid System Kit 1669

# > Instructions

**VOLKSWAGEN** Passat, 4-dr Sedan, \*12-

\*North America

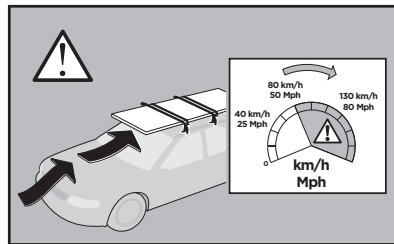
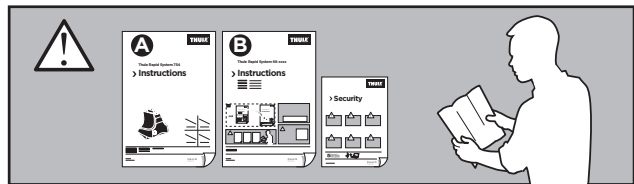
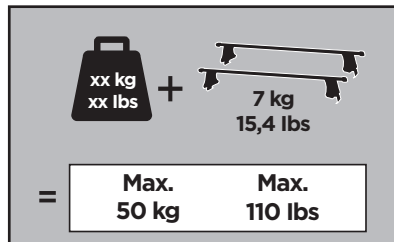

ISO 11154-E

141669

C.20130619  
519-1669-01

Bring your life  
thule.com



163 x2



164 x2

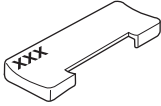

50993

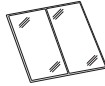

x2



1202 x1

1203 x1

1204 x1

1205 x1



x1



x1

1

	X (scale)	X (mm)	X (inch)
<b>VOLKSWAGEN Passat, 4-dr Sedan, *12-</b>	<b>44</b>	<b>1091</b>	<b>43</b>

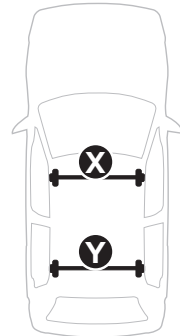
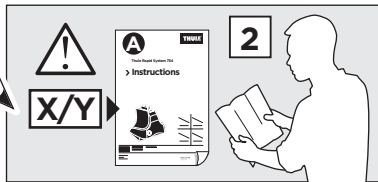
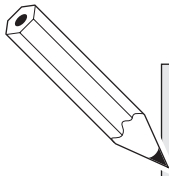

	Y (scale)	Y (mm)	Y (inch)
<b>VOLKSWAGEN Passat, 4-dr Sedan, *12-</b>	<b>39,5</b>	<b>1046</b>	<b>41</b>

2

VOLKSWAGEN **Passat**, 4-dr Sedan, \*12-

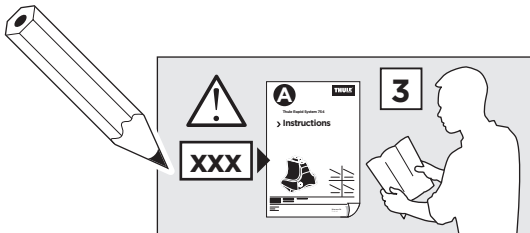
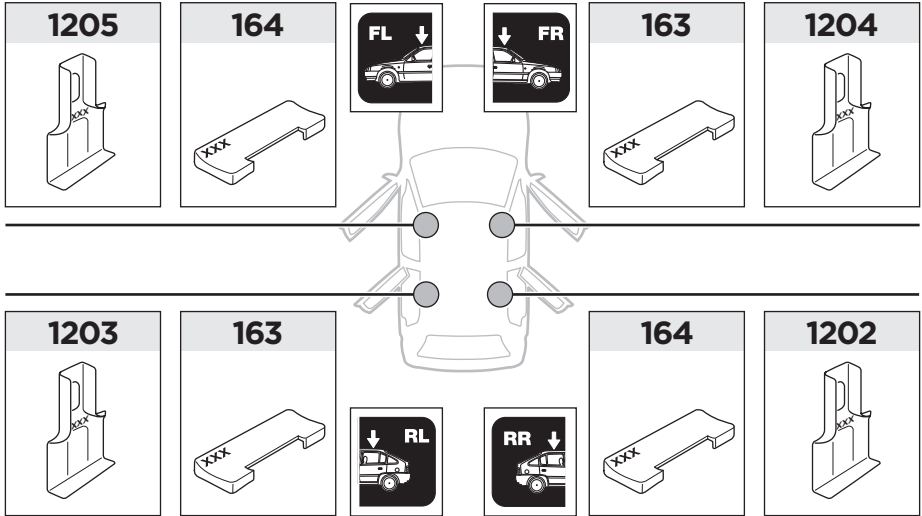

3



	W (mm)	Z (mm)	W (inch)	Z (inch)
<b>VOLKSWAGEN Passat, 4-dr Sedan, *12-</b>	<b>270</b>	<b>775</b>	<b>10 <sup>5</sup>/<sub>8</sub></b>	<b>30 <sup>1</sup>/<sub>4</sub></b>

